

Total solder points: 29

Difficulty level: *beginner* 1  2  3  4  5  *advanced*

## UNIVERSAL MONO PREAMPLIFIER

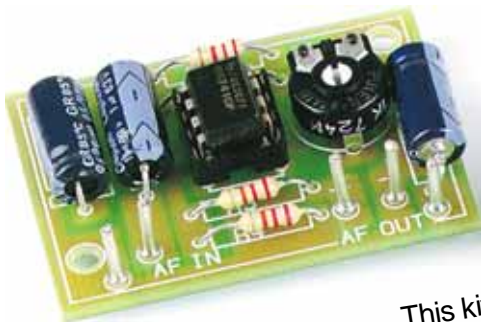

# *K1803*

This kit has been developed as pre-module for a number of audio applications where there is insufficient input signal. Applications as a microphone pre-amplifier or for level correction.

**SPECIFICATIONS:**

- Power supply: 10-30VDC / 10mA.
- Output impedance: 1Kohm.
- Adjustable output level: max. 40dB.
- Frequency range: 20Hz to 20kHz  $\pm$  3dB.
- Max. input signal: 40mV.
- PCB dimensions: 30 x 44mm (1.2" x 1.7").

**1. Assembly (Skipping this can lead to troubles !)**

Ok, so we have your attention. These hints will help you to make this project successful. Read them carefully.

**1.1 Make sure you have the right tools:**

- A good quality soldering iron (25-40W) with a small tip.
- Wipe it often on a wet sponge or cloth, to keep it clean; then apply solder to the tip, to give it a wet look. This is called 'thinning' and will protect the tip, and enables you to make good connections. When solder rolls off the tip, it needs cleaning.
- Thin rosin-core solder. Do not use any flux or grease.
- A diagonal cutter to trim excess wires. To avoid injury when cutting excess leads, hold the lead so they cannot fly towards the eyes.
- Needle nose pliers, for bending leads, or to hold components in place.
- Small blade and Phillips screwdrivers. A basic range is fine.

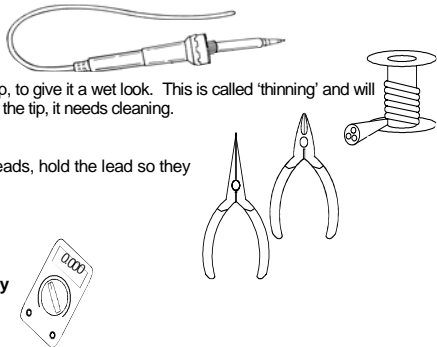

**For some projects, a basic multi-meter is required, or might be handy**

**1.2 Assembly Hints :**

- ⇒ Make sure the skill level matches your experience, to avoid disappointments.
  - ⇒ Follow the instructions carefully. Read and understand the entire step before you perform each operation.
  - ⇒ Perform the assembly in the correct order as stated in this manual
  - ⇒ Position all parts on the PCB (Printed Circuit Board) as shown on the drawings.
  - ⇒ Values on the circuit diagram are subject to changes.
  - ⇒ Values in this assembly guide are correct\*
  - ⇒ Use the check-boxes to mark your progress.
  - ⇒ Please read the included information on safety and customer service
- \* Typographical inaccuracies excluded. Always look for possible last minute manual updates, indicated as 'NOTE' on a separate leaflet.

### 1.3 Soldering Hints :

1- Mount the component against the PCB surface and carefully solder the leads

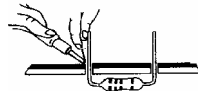

2- Make sure the solder joints are cone-shaped and shiny

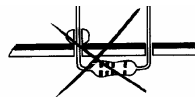
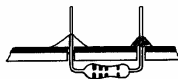

3- Trim excess leads as close as possible to the solder joint



REMOVE THEM FROM THE TAPE ONE AT A TIME !

**AXIAL COMPONENTS ARE TAPED IN THE  
CORRECT MOUNTING SEQUENCE !**

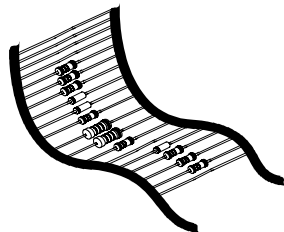

 You will find the colour code for the resistances and the LEDs in the HALG (general manual) and on our website: <http://www.velleman.be/common/service.aspx>

## 1. Resistors

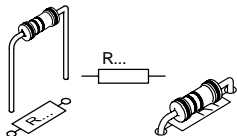

- R1 : 2K2 (2 - 2 - 2 - B)
- R2 : 220K (2 - 2 - 4 - B)
- R3 : 22K (2 - 2 - 3 - B)
- R4 : 22K (2 - 2 - 3 - B)

## 2. Trim potentiometer

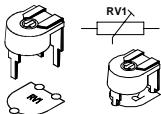

- RV1 : 1K

## 3. Electrolytic capacitors. Watch the polarity !

- C1 : 10 $\mu$ F
- C2 : 1 $\mu$ F
- C3 : 1 $\mu$ F

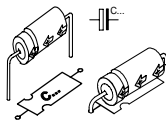

## 4. IC socket, Watch the position of the

- IC1 : 8p

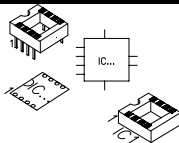

## 5. PCB pins

- AF IN (2x)
- AF OUT
- +
- 

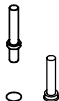

## 6. IC mounting

- IC1 : UA741M

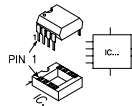

☞ Pay attention to the position of the notch!

## 7. Connection

- Connect a stabilized supply between 10 and 30V with the points “+” and “-” on the print.
- The input is connected on the points “AF IN”.
- The output is taken between the outer right connection “AF OUT” and the mass “-”.

 **To connect your in- and output you'd better use a screened wire, this to avoid interferences and rumble.**

- With the trimmer RV1 you can control the output signal between 0 and max.

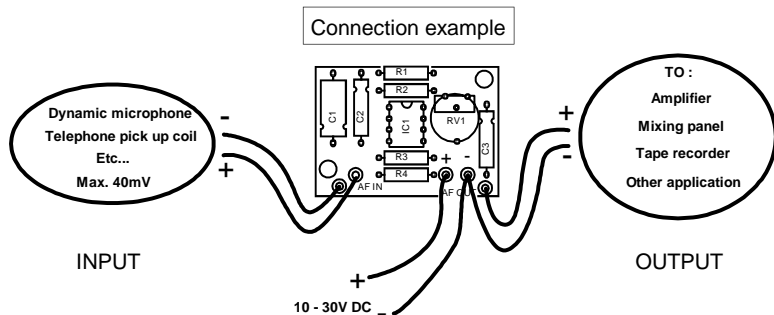

## 8. Schematic diagram.

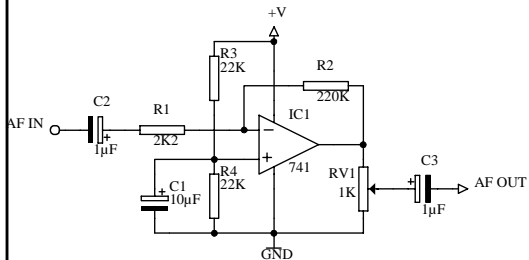

## 9. PCB

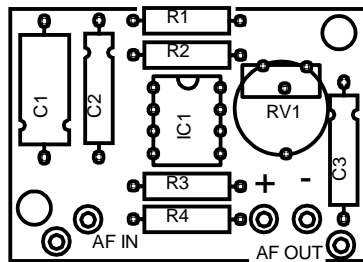



Modifications and typographical errors reserved  
© Velleman Components nv.  
H1803IP - 2004 - ED1 (rev1)

